

Article number: 12501000040100

Description: KLEE-coil 501 000 040.100  
M4 Hardened, zinc-pl./chr. yellow

## Measures

---

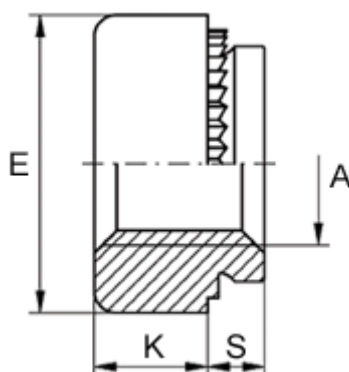

Female thread A	= M4
Height K	= 2.0
Max recess height	= 1.0
Min distance to edge	= 4.0
Outer diameter E	= 8.0
Plate thickness	= 1.1 to 1.4
Recommended bore diameter +0.05	= 5.00